



# LHR Series-High Rate

## LHR12430W(12V430W)



### Specifications

Rated Voltage	12V	
Nominal Rate ( $W_{15}, 1.67V/cell$ )	430W	
Nominal Capacity( $C_{10}, 1.80V/cell$ )	100Ah	
Dimension	Length	330±2mm (12.99 inches)
	Width	173±2mm (6.81 inches)
	Container Height	213±2mm (8.39 inches)
	Total Height	216±2mm (8.50 inches)
Approx. Weight	30.8 Kg (67.9 lbs)	
Terminal	M8	
Container Material	ABS(UL94 V-0)	
Rated Capacity (25°C)	100.0 Ah	(10hr, 10.0A, 1.80V/cell)
	97.6 Ah	(8hr, 12.2A, 1.80V/cell)
	89.0 Ah	(5hr, 17.8A, 1.75V/cell)
	78.3 Ah	(3hr, 26.1A, 1.75V/cell)
	67.0 Ah	(1hr, 67.0A, 1.67V/cell)
Max. Discharge Current	1500A	
Internal Resistance (25°C)	Approx. 3.5mΩ	
Operating Temp. Range	Discharge	-20 ~ 55°C (4 ~ 131°F)
	Charge	0 ~ 40°C (32 ~ 104°F)
	Storage	-15 ~ 50°C (5 ~ 122°F)
Nominal Operating Temp. Range	25±3°C (77±5°F)	
Max. Charging Current(25°C)	25A	
Charge voltage(25°C)	Float	13.5V
	Temp. Coefficient	-3mV/cell/°C
	Equalization	14.1~14.4V
Effect of temp. to Capacity	40°C (104°F)	106%
	25°C (77°F)	100%
	0°C (32°F)	86%
Self Discharge	≤3%/month @ 25°C	



### Layout

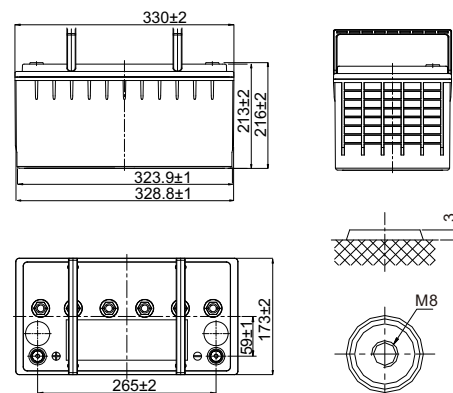

### Constant Current Discharge (Amperes) at 25 °C (77°F)

F.V/Time	5min	10min	15min	20min	30min	45min	1h	1.5h	2h	3h	4h	5h	8h	10h
1.85V/cell	294.7	231.6	186.2	145.5	102.0	73.1	57.3	40.9	32.6	24.0	19.6	16.7	11.9	9.70
1.80V/cell	335.8	258.8	208.5	163.0	108.3	77.6	60.9	43.2	34.3	25.1	20.4	17.3	12.2	10.0
1.75V/cell	362.9	271.3	218.6	174.3	113.8	80.9	63.5	44.8	35.6	26.1	21.0	17.8	12.3	10.1
1.70V/cell	385.7	281.4	224.1	183.5	118.9	83.5	65.3	46.3	36.7	26.7	21.5	18.2	12.5	10.2
1.67V/cell	397.8	290.8	230.5	189.4	122.9	85.6	67.0	47.3	37.5	27.2	21.8	18.4	12.6	10.3
1.60V/cell	403.8	299.3	238.1	192.9	126.3	87.4	68.4	48.2	38.2	27.9	22.3	18.8	12.7	10.4

### Constant Power Discharge (Watts/cell) at 25 °C (77°F)

F.V/Time	5min	10min	15min	20min	30min	45min	1h	1.5h	2h	3h	4h	5h	8h	10h
1.85V/cell	544.7	452.1	359.6	290.0	209.9	148.3	115.6	82.1	65.3	48.3	39.8	34.1	24.1	20.1
1.80V/cell	615.6	503.9	400.8	315.2	225.1	157.0	122.3	86.2	68.1	50.1	41.0	35.1	24.5	20.5
1.75V/cell	663.5	525.8	418.3	336.3	236.7	164.9	128.0	90.2	71.3	51.9	42.2	36.0	24.9	20.6
1.70V/cell	705.1	532.4	423.6	350.8	245.6	171.1	132.3	93.0	73.2	53.4	43.3	36.7	25.2	20.8
1.67V/cell	731.0	540.5	430.0	358.7	251.9	175.6	135.5	95.0	74.7	54.5	44.1	37.1	25.6	21.0
1.60V/cell	741.5	548.7	443.2	362.6	255.2	178.1	137.7	96.7	76.0	55.1	44.6	37.6	25.9	21.2



# LHR Series-High Rate

## LHR12430W(12V430W)



### Applications

- UPS
- Hospitals & Testing Laboratories
- Emergency Power Supply
- Industrial Process Control Facilities
- Banks & Financial Markets
- Data & Network Operation Centers

### General Features

- ABS material: UL94 V-0
- Oxygen recombination efficiency:  $\geq 98\%$
- High quality AGM separator: extend cycle life and prevent micro short circuit
- Unique vent valve design: reduce water losing and prevent air/spark going inside
- PbCaSn alloy for plate grids: less gassing, less self-discharging

### Standards

- Compliance with IEC 60896 standards
- Classified as "Long Life" according to Eurobat
- CE, UL Certified
- Manufactured in Leoch@IATF16949, OHSAS 18001, ISO 9001 and ISO 14001 certified production facilities

### Discharge Characteristics

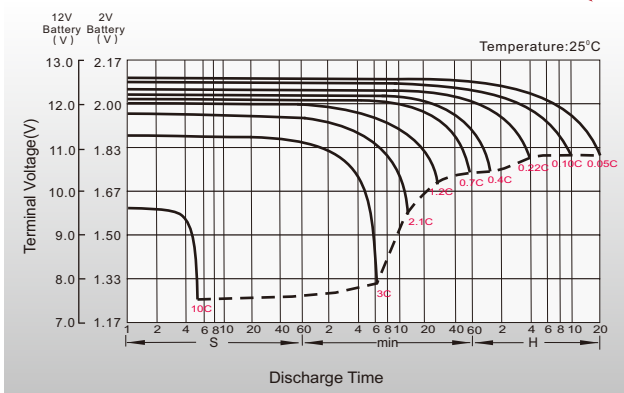

### Float Charging Characteristics

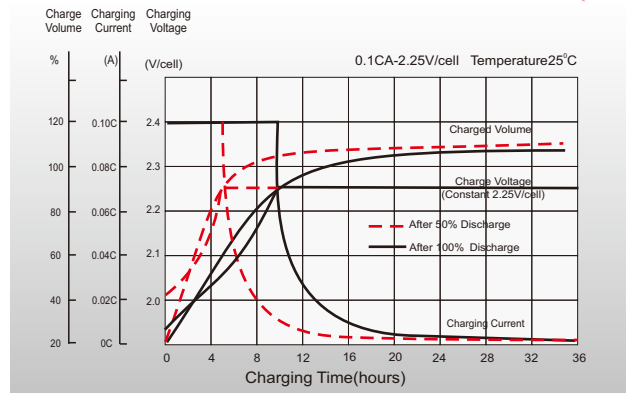

### Temperature Effects in Relation to Battery Capacity

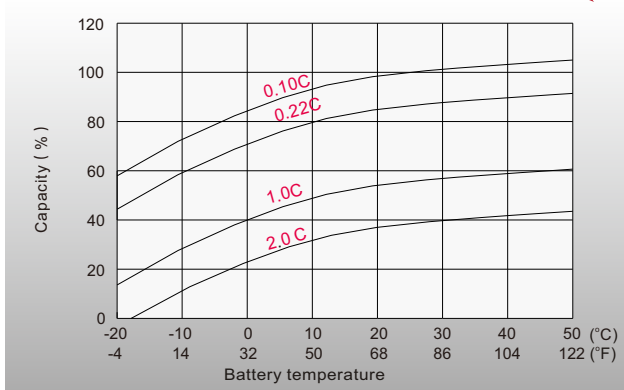

### Temperature Effects on Long Term Float Life

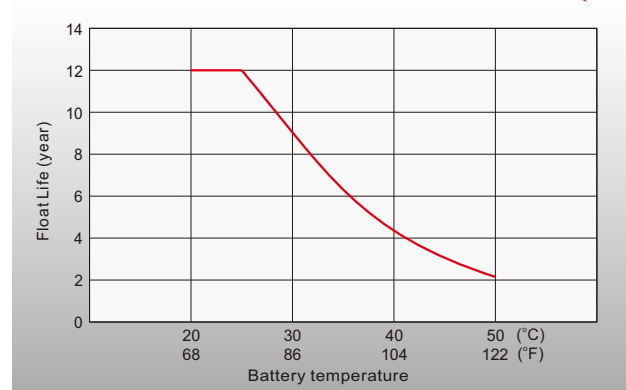

## Sales Offices Worldwide

#### China Sales Office

5th Floor, Xinbaohui Bldg., Nanhai Blvd.,  
Nanshan, Shenzhen, China. 518052  
Tel: +86-755-86036060 (100 lines)  
Fax: +86-755-26067269  
E-mail: export@leoch.com

#### HongKong Sales Office

Workshop C, 33/F, TML Tower, No. 3 Hoi Shing Road,  
Tsuen Wan, New Territories, Hong Kong  
Tel: +852 35786666  
Fax: +44 1452 690125  
E-mail: sales.hk@leoch.com

#### Singapore Sales Office

No. 1 Tech Park Crescent,  
Singapore 638131  
Tel: +65 68636078  
Fax: +65 6863 6079  
Email: sales.sg@Leoch.com

#### Australia Sales Office

2 /29 Tarlington Place, Smithfield. NSW 2164  
Australia  
Tel: 02 9756 0950  
E-mail: sales.au@leoch.com

#### North America Sales Office

19751 Descartes  
Foothill Ranch, CA 92610, USA  
Tel: 949-588-5853  
Fax: 949-588-5966  
E-mail: sales@leoch.us  
Http:// www.leoch.us

#### UK Sales Office

9B Wheatstone Court, Waterwells, Business Park,  
Gloucester, GL2-2AQ, UK United Kingdom  
Tel: +44(0) 1452 729428 / 1452 729696  
Fax: +44 1452 690125  
E-mail: Sales.Europe@leoch.com  
Http:// www.leoch.eu

#### EMEA Sales Office

1 Deligiorgi St., 121 31 Athens,  
Greece  
Tel: +30 210 5760318 (2 lines)  
E-mail: support\_EMEA@leoch.com  
Http:// www.leoch.eu

#### India Sales Office

Shed no.A-53(b), 2nd Stage of Peenya Industrial Area,  
Bangalore North Taluk, Bangalore-560058, India  
Tel: +91-80-23440018/23440019  
Fax: +91-80-23440017  
E-mail: indiasales@leoch.com



[Http://www.leoch.com](http://www.leoch.com)

© 2019 LEOCH. All rights reserved.

Trademarks and logos are the property of LEOCH and its affiliates unless otherwise noted.  
Subject to revisions without prior notice.

Publication No.: LB-LHR12430W-PD-EN-V1.1-201907