



LHR Series-High Rate

LHR12690W(12V690W)



Specifications

Rated Voltage	12V	
Nominal Rate ($W_{15}, 1.67V/cell$)	690W	
Nominal Capacity($C_{10}, 1.80V/cell$)	200Ah	
Dimension	Length	522±3mm (20.55 inches)
	Width	240±3mm (9.45 inches)
	Container Height	218±3mm (8.58 inches)
	Total Height	224±3mm (8.82 inches)
Approx. Weight	62.2 Kg (137.1 lbs)	
Terminal	M8	
Container Material	ABS(UL94 V-0)	
Rated Capacity (25°C)	200.0 Ah	(10hr, 20.0A, 1.80V/cell)
	192.0 Ah	(8hr, 24.0A, 1.80V/cell)
	175.0 Ah	(5hr, 35.0A, 1.75V/cell)
	159.0 Ah	(3hr, 53.0A, 1.75V/cell)
	128.0 Ah	(1hr, 128.0A, 1.67V/cell)
Max. Discharge Current	2000A	
Internal Resistance (25°C)	Approx. 2.7mΩ	
Operating Temp. Range	Discharge	-20 ~ 55°C (4 ~ 131°F)
	Charge	0 ~ 40°C (32 ~ 104°F)
	Storage	-15 ~ 50°C (5 ~ 122°F)
Nominal Operating Temp. Range	25±3°C (77±5°F)	
Max. Charging Current(25°C)	50.0A	
Charge voltage(25°C)	Float	13.5V
	Temp. Coefficient	-3mV/cell/°C
	Equalization	14.1~14.4V
Effect of temp. to Capacity	40°C (104°F)	106%
	25°C (77°F)	100%
	0°C (32°F)	86%
Self Discharge	≤3%/month @ 25°C	



Layout

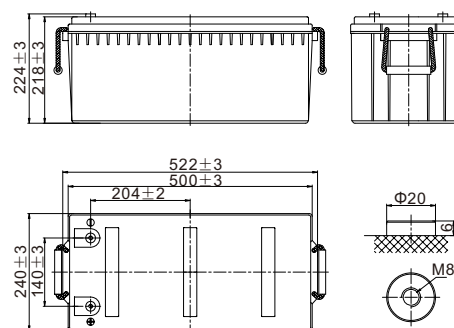

Constant Current Discharge (Amperes) at 25 °C (77°F)

F.V/Time	5min	10min	15min	20min	30min	45min	1h	1.5h	2h	3h	4h	5h	8h	10h
1.85V/cell	416.3	310.7	258.8	217.5	167.2	124.7	105.4	79.0	63.3	47.7	38.0	31.8	22.4	18.7
1.80V/cell	485.2	366.4	301.0	250.6	189.0	139.5	116.6	86.5	68.8	51.6	41.0	34.2	24.0	20.0
1.75V/cell	529.5	392.9	318.4	263.0	197.5	145.2	120.9	89.4	70.9	53.0	42.0	35.0	24.4	20.3
1.70V/cell	573.5	419.1	336.5	276.7	206.2	150.7	125.4	92.4	73.2	54.6	43.1	35.8	24.9	20.6
1.67V/cell	598.8	434.4	347.1	284.5	211.4	154.0	128.0	94.1	74.4	55.4	43.7	36.2	25.1	20.8
1.60V/cell	660.0	470.0	372.0	303.0	223.4	162.0	134.2	98.3	77.5	57.4	45.1	37.4	25.7	21.3

Constant Power Discharge (Watts/cell) at 25 °C (77°F)

F.V/Time	5min	10min	15min	20min	30min	45min	1h	1.5h	2h	3h	4h	5h	8h	10h
1.85V/cell	830.4	624.5	528.1	440.0	339.2	254.0	204.8	154.1	123.6	93.5	74.7	62.5	44.3	37.1
1.80V/cell	953.4	727.6	606.4	502.1	380.3	281.9	225.2	167.6	133.8	100.8	80.2	67.2	47.3	39.5
1.75V/cell	1024.5	770.7	634.5	521.8	394.1	291.1	231.8	172.2	137.2	103.0	81.9	68.5	48.1	40.1
1.70V/cell	1091.5	811.2	663.5	543.6	407.8	299.8	238.7	177.0	140.8	105.6	83.7	69.8	48.8	40.6
1.67V/cell	1128.7	834.4	690.0	555.5	415.8	305.0	242.5	179.5	142.7	106.9	84.7	70.6	49.3	40.9
1.60V/cell	1140.0	884.5	708.1	582.2	433.7	317.3	251.9	186.0	147.5	110.2	87.0	72.4	50.3	41.7



LHR Series-High Rate

LHR12690W(12V690W)



Applications

- UPS
- Hospitals & Testing Laboratories
- Emergency Power Supply
- Industrial Process Control Facilities
- Banks & Financial Markets
- Data & Network Operation Centers

General Features

- ABS material: UL94 V-0
- Oxygen recombination efficiency: $\geq 98\%$
- High quality AGM separator: extend cycle life and prevent micro short circuit
- Unique vent valve design: reduce water losing and prevent air/spark going inside
- PbCaSn alloy for plate grids: less gassing, less self-discharging

Standards

- Compliance with IEC 60896 standards
- Classified as "Long Life" according to Eurobat
- CE, UL Certified
- Manufactured in Leoch@IATF16949, OHSAS 18001, ISO 9001 and ISO 14001 certified production facilities

Discharge Characteristics

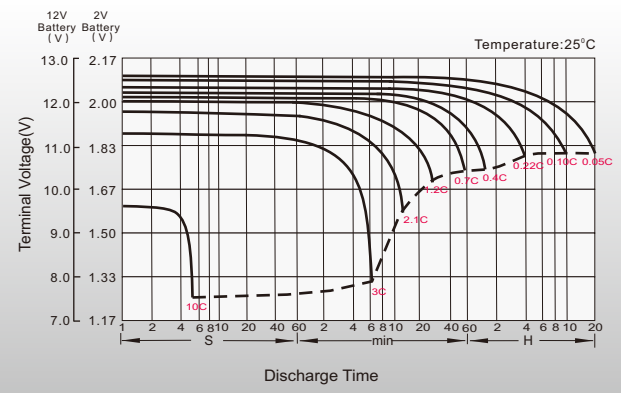

Float Charging Characteristics

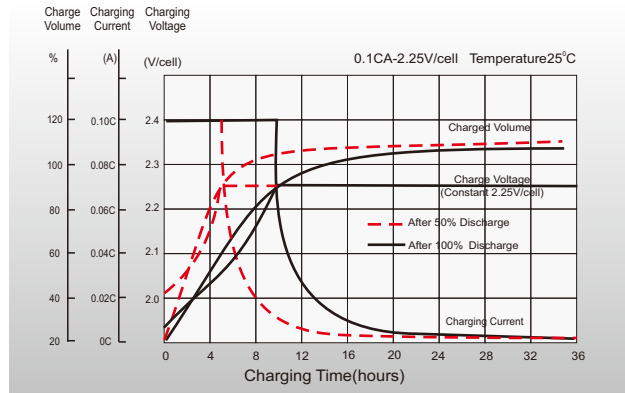

Temperature Effects in Relation to Battery Capacity

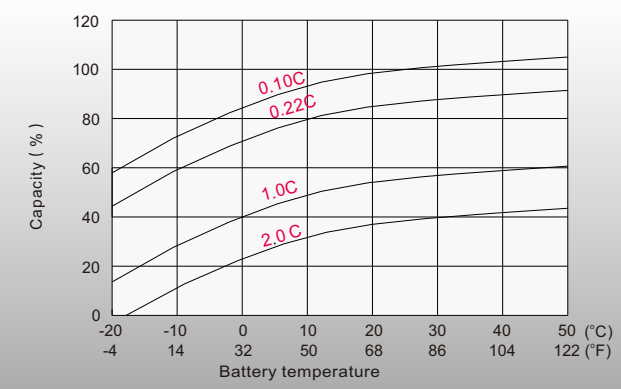

Temperature Effects on Long Term Float Life

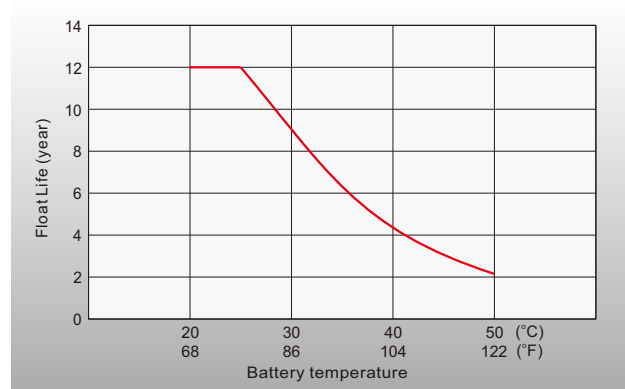

Sales Offices Worldwide

China Sales Office

5th Floor, Xinbaohui Bldg., Nanhai Blvd.,
Nanshan, Shenzhen, China. 518052
Tel: +86-755-86036060 (100 lines)
Fax: +86-755-26067269
E-mail: export@leoch.com

HongKong Sales Office

Workshop C, 33/F, TML Tower, No. 3 Hoi Shing Road,
Tsuen Wan, New Territories, Hong Kong
Tel: +852 35786666
Fax: +44 1452 690125
E-mail: sales.hk@leoch.com

Singapore Sales Office

No. 1 Tech Park Crescent,
Singapore 638131
Tel: +65 68636078
Fax: +65 6863 6079
Email: sales.sg@Leoch.com

Australia Sales Office

2 /29 Tarlington Place, Smithfield. NSW 2164
Australia
Tel: 02 9756 0950
E-mail: sales.au@leoch.com

North America Sales Office

19751 Descartes
Foothill Ranch, CA 92610, USA
Tel: 949-588-5853
Fax: 949-588-5966
E-mail: sales@leoch.us
Http:// www.leoch.us

UK Sales Office

9B Wheatstone Court, Waterwells, Business Park,
Gloucester, GL2-2AQ, UK United Kingdom
Tel: +44(0) 1452 729428 / 1452 729696
Fax: +44 1452 690125
E-mail: Sales.Europe@leoch.com
Http:// www.leoch.eu

EMEA Sales Office

1 Deligiorgi St., 121 31 Athens,
Greece
Tel: +30 210 5760318 (2 lines)
E-mail: support_EMEA@leoch.com
Http:// www.leoch.eu

India Sales Office

Shed no. A-53(b), 2nd Stage of Peenya Industrial Area,
Bangalore North Taluk, Bangalore-560058, India
Tel: +91-80-23440018/23440019
Fax: +91-80-23440017
E-mail: indiasales@leoch.com



[Http://www.leoch.com](http://www.leoch.com)

© 2019 LEOCH. All rights reserved.

Trademarks and logos are the property of LEOCH and its affiliates unless otherwise noted.
Subject to revisions without prior notice.

Publication No.: LB-LHR12690W-PD-EN-V1.1-201907